

Note that all unique customer requirements (i.e tolerance) need to be verified thru Alfa Laval.

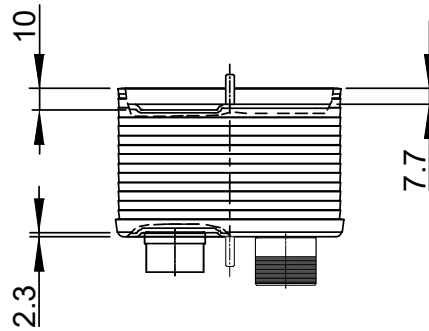
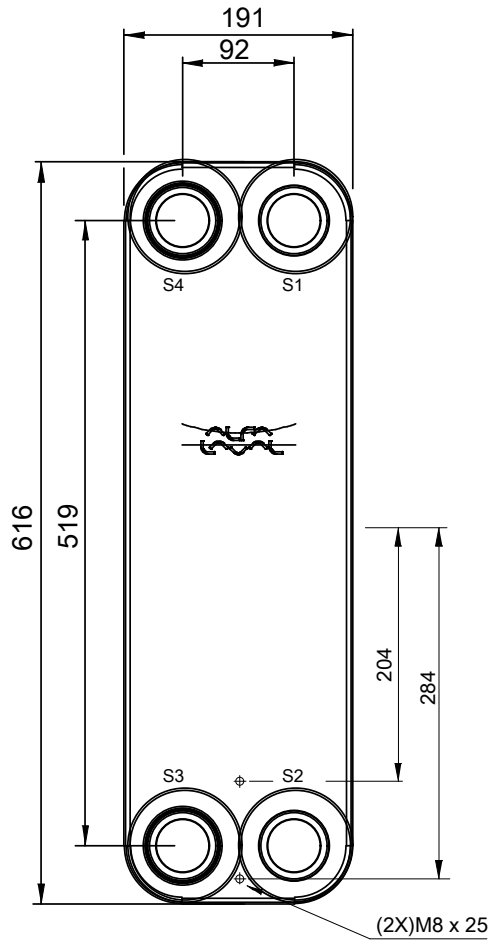
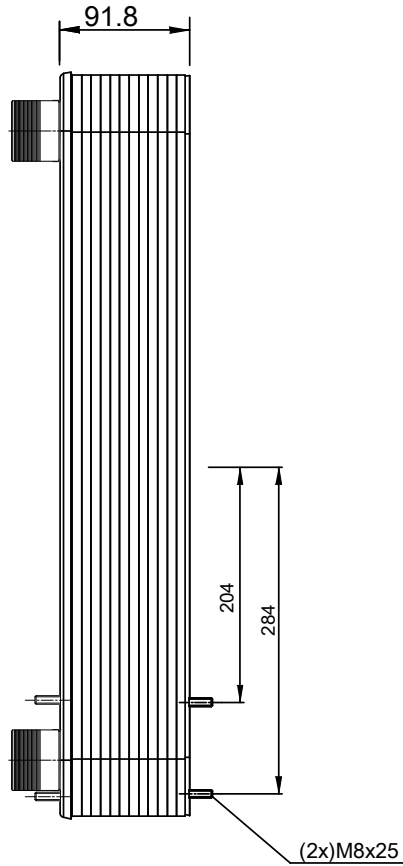
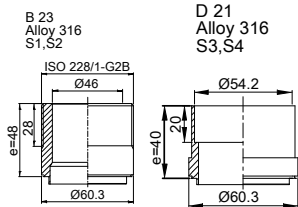

HEATING SURFACE
NETWEIGHT 16.5 kg
OPERATING WEIGHT
PLATE MATERIAL Alloy 316
PLATE GROUPING 1*14ML/1*15MH

ALL DIMENSIONS IN MILLIMETERS

SIDE	MEDIA	INLET	TEMP.	OUTLET	TEMP.	FLOW RATE	PRESSURE DROP	LIQUID VOL.
1								2.94 dm ³
2								3.15 dm ³

PRESSURE VESSEL APPROVAL

PED

CB110-30M (3287118756)

www.alfalaval.com

CUSTOMER NAME / REF. NO.

TOTAL LENGTH 154.8 mm
TOTAL WIDTH 191.0 mm
TOTAL HEIGHT 616.0 mm

COMPANY / REF.



5/20/2021
REV 0