

Note that all unique customer requirements (i.e tolerance) need to be verified thru Alfa Laval.

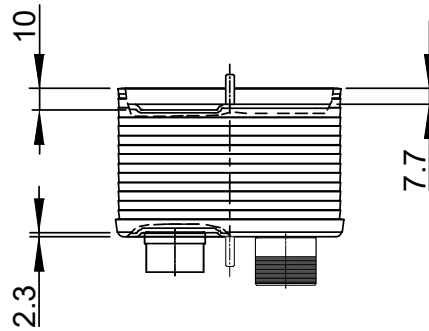
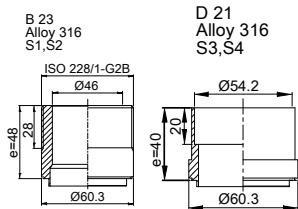
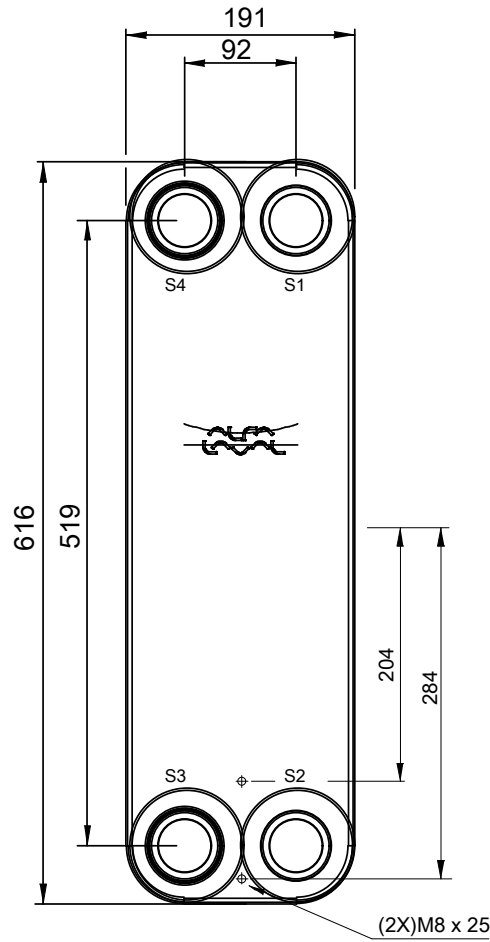
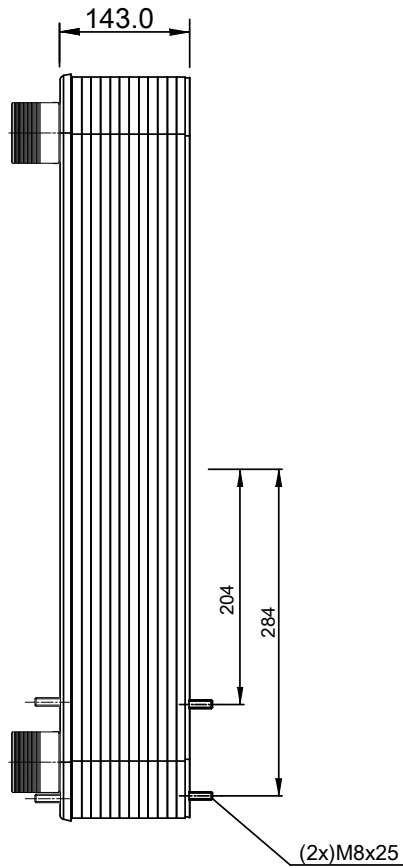

HEATING SURFACE
 NETWEIGHT 23.5 kg
 OPERATING WEIGHT
 PLATE MATERIAL Alloy 316
 PLATE GROUPING 1*24L/1*25L

ALL DIMENSIONS IN MILLIMETERS

SIDE	MEDIA	INLET	TEMP.	OUTLET	TEMP.	FLOW RATE	PRESSURE DROP	LIQUID VOL.
1								5.04 dm ³
2								5.25 dm ³

PRESSURE VESSEL APPROVAL

PED

CB110-50L (3287118749)

www.alfalaval.com

CUSTOMER NAME / REF. NO.

TOTAL LENGTH 206.0 mm
 TOTAL WIDTH 191.0 mm
 TOTAL HEIGHT 616.0 mm

COMPANY / REF.



5/20/2021
 REV 0