

Note that all unique customer requirements (i.e tolerance) need to be verified thru Alfa Laval.

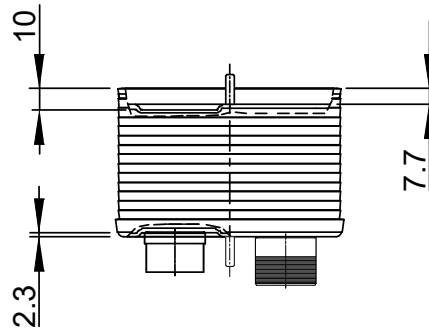
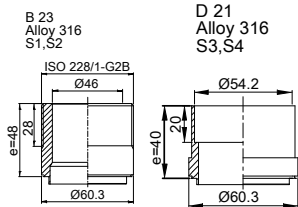
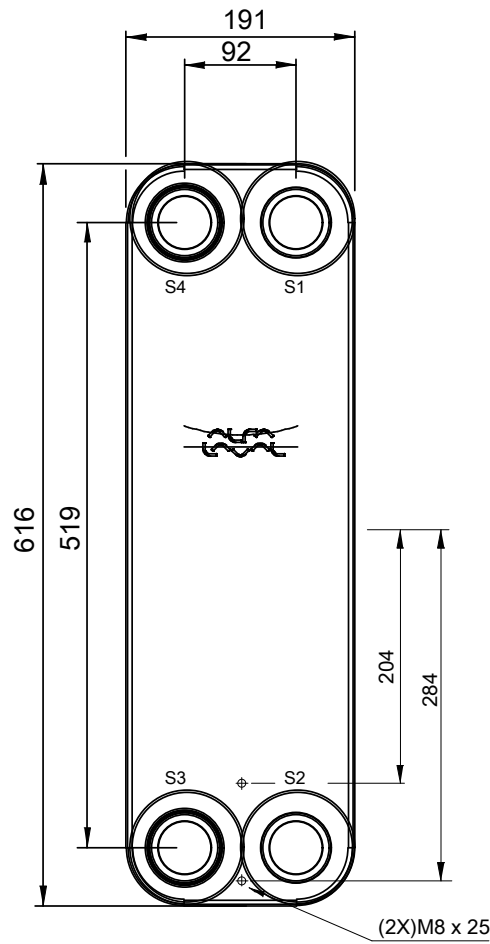
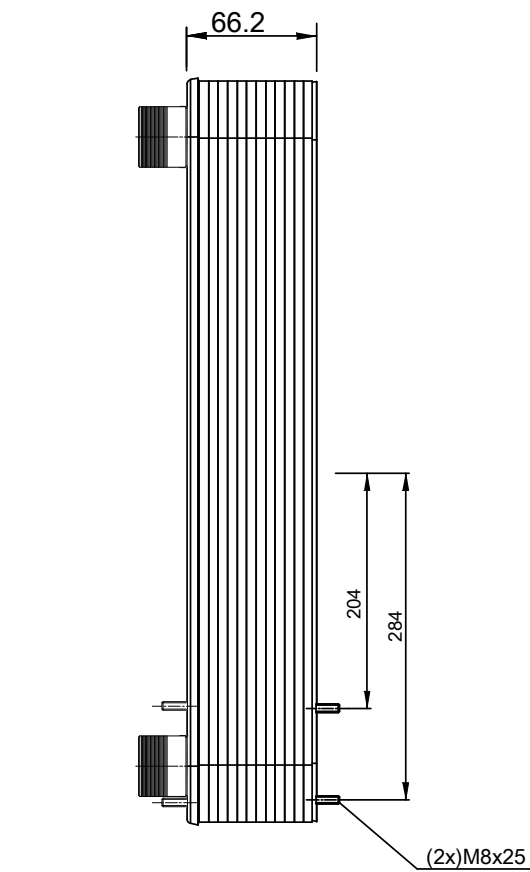

HEATING SURFACE  
 NETWEIGHT 13.0 kg  
 OPERATING WEIGHT  
 PLATE MATERIAL Alloy 316  
 PLATE GROUPING 1\*9L/1\*10L

ALL DIMENSIONS IN MILLIMETERS

SIDE	MEDIA	INLET	TEMP.	OUTLET	TEMP.	FLOW RATE	PRESSURE DROP	LIQUID VOL.
1								1.89 dm <sup>3</sup>
2								2.1 dm <sup>3</sup>

PRESSURE VESSEL APPROVAL

PED

CB110-20L (3287118746)

[www.alfalaval.com](http://www.alfalaval.com)

CUSTOMER NAME / REF. NO.

TOTAL LENGTH 129.2 mm  
 TOTAL WIDTH 191.0 mm  
 TOTAL HEIGHT 616.0 mm

COMPANY / REF.



5/20/2021  
 REV 0